

Assembly Instructions

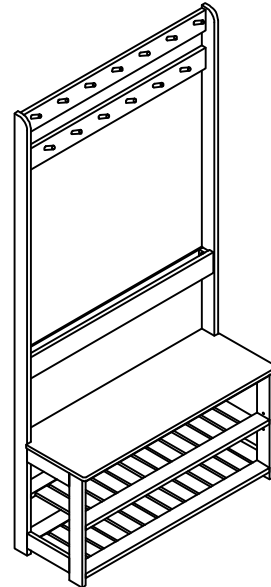

Hallway Storage - Parker Wide Shoe Bench & Hanger

ROPO no:



PLEASE READ THESE INSTRUCTIONS VERY CAREFULLY BEFORE YOU BEGIN, TO ENSURE THAT YOUR FUTON COMPANY PRODUCT WILL GIVE YOU MANY YEARS OF SATISFACTION

Thank you for buying Futon Company product

We are constantly striving to improve everything we do, but very occasionally mistakes do occur.

In the unlikely event that you find any part missing please call your nearest Futon Company store and we will arrange for the despatch of an immediate replacement.

Please keep all packaging until you have checked every part and assembly of your

Futon Company product is complete.

Version number: 1 Product code: ST PARKER WIDE Date: 12/04/24

experts in small space living



Parts Checklist





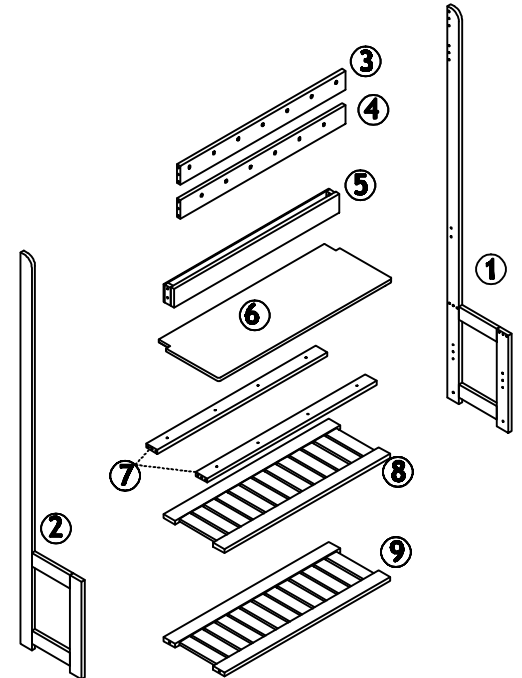



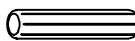
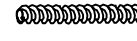

Please count and check every component very carefully before you begin

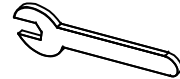
- ① Left Side x 1
- ② Right Side x 1
- ③ Upper Back Bar x 1
- ④ Lower Back Bar x 1
- ⑤ Box Bar x 1
- ⑥ Seat x 1
- ⑦ Seat Support Rails x 2
- ⑧ Middle Shelf x 1
- ⑨ Bottom Shelf x 1



Fittings Checklist

Please count and check every component very carefully before you begin

- 

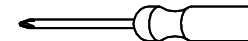

- a** Dowel x 16 **b** Bolt x 12 **c** Pressure Plate x 12 **d** Nut x 12
- 

- e** Small Spanner x 1 **f** Allen Key x 1 **g** Allen Head Bolt x 2
- 

- h** Screw x 8 **i** Shelf Support x 4 **j** Felt Protector Pad x 4
- 

- k** peg x 13 **m** Dowel (6x20) x 2



* Cross head Screwdriver also required for assembly



How To Assemble Your Bench

Please follow these instructions carefully

FUTON

C O M P A N Y



How To Use

Please read carefully

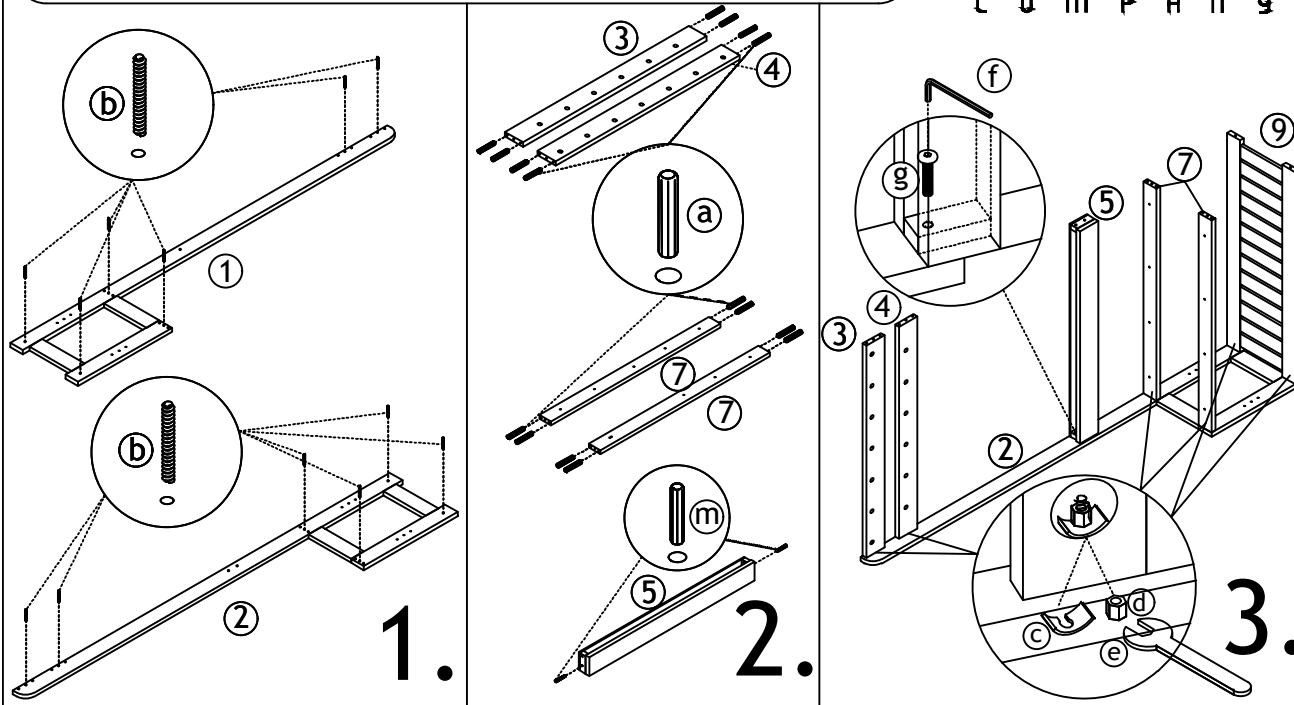

FINISH
Your Bench is made from solid oak with an oil and lacquer satin finish.

CARE
Wipe with a soft damp cloth. To spot clean your Bench, rub with fine wire wool along the grain and very lightly re-oil with boiled linseed oil and allow 48 hours to dry.

IMPORTANT
To ensure maximum performance from this product, we advise that you check and tighten all bolts and screws on a regular basis to avoid damage and strain to parts.

GUARANTEE
This instruction leaflet forms part of your guarantee, please retain it. The ROPO number along with your invoice number will need to be quoted in all correspondence with Futon Company.

Thank you for choosing Futon Company.

