

## Assembly Instructions

**FUTON**  
C O M P A N Y

# Shelving - Folio Short Birch Bookcase

ROPO no:

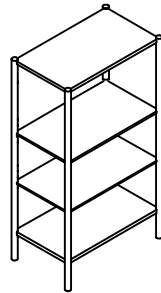

**PLEASE READ THESE INSTRUCTIONS VERY CAREFULLY BEFORE YOU BEGIN, TO ENSURE THAT YOUR FUTON COMPANY PRODUCT WILL GIVE YOU MANY YEARS OF SATISFACTION**

Thank you for buying a Futon Company product.

We are constantly striving to improve everything we do, but occasionally mistakes do occur. In the unlikely event that you find any part missing, please call your nearest Futon Company store and we will arrange for the despatch of an immediate replacement. Please keep all packaging until you have checked every part and assembly of your Futon Company product is complete.

Version number: 1 Product code: ST SHELF FOLIO SHRT Date: 26/04/21

*experts in small space living*



## Parts Checklist





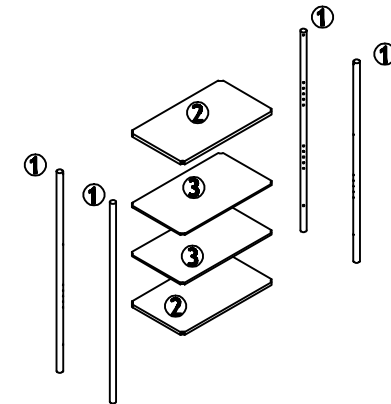



Please count and check every component very carefully before you begin

- ① Vertical pole x 4
- ② Fixed shelf x 2
- ③ Adjustable shelf x 2



## Fittings Checklist

Please count and check every component very carefully before you begin

-  a Bolt x 8
-  b Pressure Plate x 8
-  c Nut x 8
-  d Small Spanner x 1
-  e Shelf support x 8
-  f Screw x 1
-  g Wall Leash x 1
-  h Felt Protector pad x 4

\* Cross head Screwdriver also required for assembly



# How To Assemble Your Shelf

Please follow these instructions carefully

# FUTON

C O M P A N Y

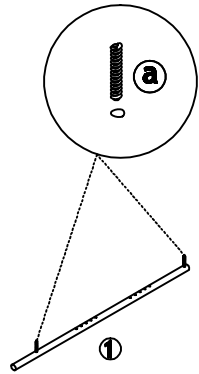

Repeat this step for all part 1's

# 1.

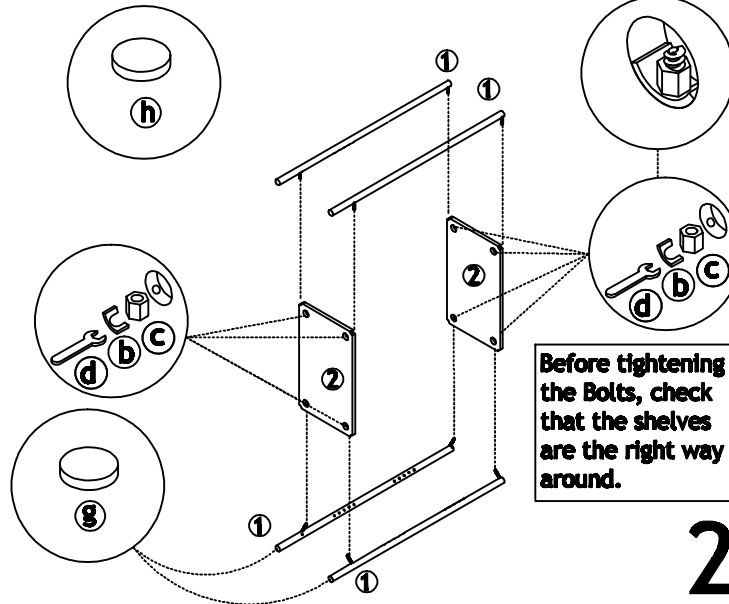

Before tightening the Bolts, check that the shelves are the right way around.

# 2.

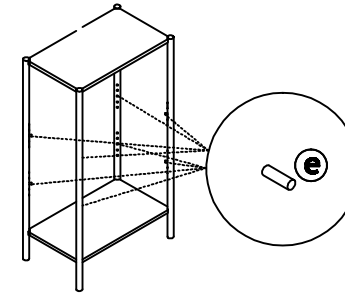

Place shelf supports at your chosen height.

# 3.

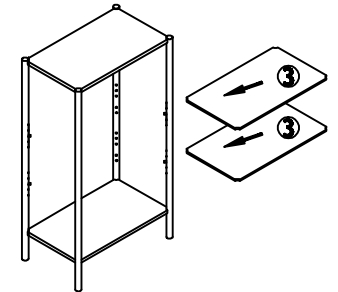

# 4.



# How To Use

Please read carefully

**IMPORTANT!** a wall leash must be used with this product

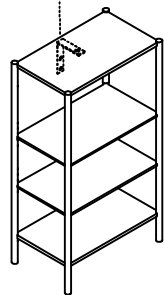

1. Before moving the unit into place establish the correct height to attach the 'wall leash' to the wall.
2. Attach the two hole end of the leash to the wall with hardware suitable for your wall. Screw fixings to attach the leash to the wall are not included as different wall materials require different types of fixing. Contact your local specialised hardware store for advice on suitable fixing.
3. Move your furniture into place and attach the one hole end of the leash, with the supplied wood screw, 1 cm from the rear/underside edge in the frame of the unit.

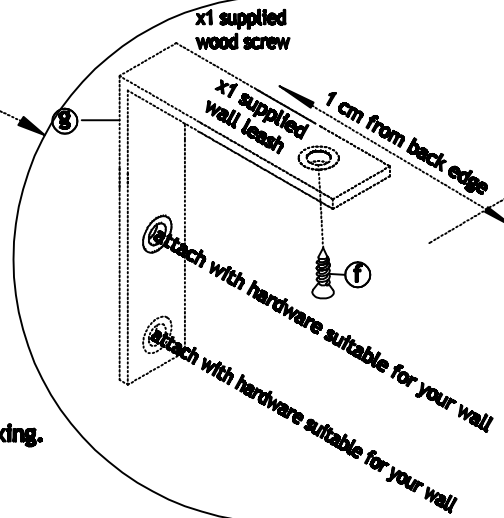

# 5.

## FINISH

Timber may be selected to ensure that the visible surfaces are of a higher grade than unseen surfaces. These unseen areas are not finished to the same standard as the visible surfaces.

## CARE

To clean your Shelf, wipe with a damp cloth followed by a dry cloth.

## IMPORTANT

To ensure maximum performance from this product, we advise that you check and tighten all bolts and screws on a regular basis to avoid damage and strain to parts.

## GUARANTEE

This instruction leaflet forms part of your guarantee, please retain it. The ROPO number along with your invoice number will need to be quoted in all correspondence with Futon Company.

Thank you for choosing Futon Company.